

[Contents](#)

[Connections](#)

[Playback](#)

[Settings](#)

[Tips](#)

[Appendix](#)



marantz®

Integrated Amplifier

PM6005

You can print more than one page of a PDF onto a single sheet of paper.

[Front panel](#)

[Rear panel](#)

[Remote](#)

[Index](#)



Owner's Manual

Contents

Accessories	4
Inserting the batteries.....	5
Operating range of the remote control unit.....	5
Features	6
High quality sound.....	6
High performance.....	7
Easy operation.....	7

Part names and functions

Front panel	8
Rear panel	10
Remote control unit	11
Amplifier and Tuner operation.....	11
CD player operation.....	12
Network audio player operation.....	13

Connections

Speaker connection	15
Connecting the speakers cables.....	15
Speaker A/B connection.....	16
Bi-wiring connection.....	17

Connecting a playback device	18
Connecting a recording device	19
Connecting a TV/Devices with digital audio connectors	20
Connecting devices with remote control connectors	21
Performing operations by RC on this unit without visual contact.....	21
Remotely connecting Marantz devices.....	21
Connecting the power cord	22

Playback

Turning the power on.....	24
Selecting the speakers for audio output.....	25
Selecting the input source.....	25
Adjusting the volume.....	25
Turning off the sound temporarily.....	25
Adjusting the tone.....	25
Playing CDs.....	26
Recording.....	27



Settings

Setting the Auto Standby mode	<u>29</u>
Turning Auto Standby mode off	<u>29</u>
Turning Auto Standby mode on	<u>29</u>
Setting the remote signal receiving function of the remote control unit	<u>30</u>
Disabling the remote signal receiving function of the remote control unit.....	<u>30</u>
Enabling the remote signal receiving function of the remote control unit.....	<u>30</u>
Setting remote control codes	<u>31</u>
Setting remote control codes for the remote control	<u>31</u>
Setting remote control codes for this unit	<u>32</u>

Tips

Contents	<u>33</u>
Tips.....	<u>34</u>
Troubleshooting	<u>35</u>

Appendix

Playback on devices that have digital audio terminals	<u>40</u>
Explanation terms.....	<u>40</u>
Specifications	<u>41</u>
Index	<u>42</u>



Thank you for purchasing this Marantz product. To ensure proper operation, please read this owner's manual carefully before using the product. After reading this manual, be sure to keep it for future reference.

Accessories

Check that the following parts are supplied with the product.

① Getting Started

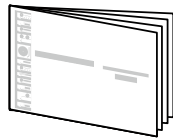

② CD-ROM (Owner's Manual)



③ Safety Instructions

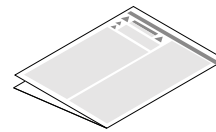

④ Warranty
(for USA)
(for CANADA)

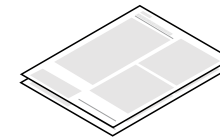

⑤ Power cord



⑥ Remote control unit
(RC001PMCD)

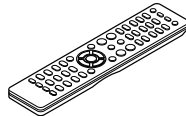

⑦ R03/AAA batteries



Inserting the batteries

- ① Remove the rear lid in the direction of the arrow and remove it.

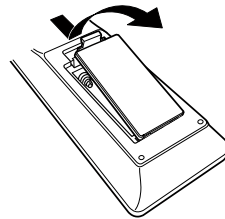

- ② Load the two batteries properly as indicated by the ⊕ and ⊖ marks in the battery compartment.

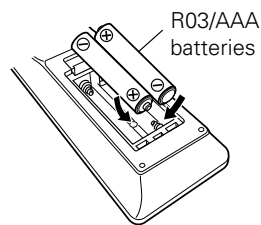

- ③ Put the rear cover back on.

NOTE

- When inserting the batteries, be sure to do so in the proper direction, following the ⊕ and ⊖ marks in the battery compartment.
- To prevent damage or leakage of battery fluid:
 - Do not use a new battery together with an old one.
 - Do not use two different types of batteries.
- Remove the batteries from the remote control unit if it will not be in use for long periods.
- If the battery fluid should leak, carefully wipe the fluid off the inside of the battery compartment and insert new batteries.

Operating range of the remote control unit

Point the remote control unit at the remote sensor when operating it.

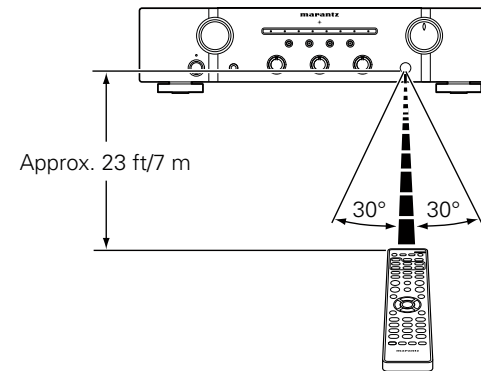

Features

High quality sound

- **All-discrete current feedback amplifier**

This unit uses a high-speed current feedback amplifier circuit for its preamplifier and power amplifier so that signals from the Super Audio CD player can be amplified with high fidelity. The high-speed current feedback amplifier reproduces a natural sound space.

- **High-power output**

This unit features a slimline body, but comes with a large power supply unit for dynamic music reproduction with high power.

- **High quality audio design**

This unit has a high quality audio design such as minimized signal path, use of high sound quality parts, and large power circuit, which is possible only in discrete audio components.

- **Phono input connectors for connecting turntables**

This unit is provided with a phono amplifier so that you can directly connect a turntable and play records (Only the MM cartridge can be used (☞ page 18)).

- **Two-sets of speaker output terminals**

In addition to using two sets of speakers (Speakers A and Speakers B), you can connect to bi-wiring speakers with separate input terminals for high range and low range (☞ page 17). The unit adopts screw terminals that can connect thick audio cables.



High performance

- **Digital Input (Coaxial, Optical)**

This unit has a digital input terminal that allows input of digital audio from external devices such as televisions.

The digital-to-analog converter is an important factor in the sound quality of digital audio input. The Marantz Super Audio CD player uses the Cirrus Logic CS4398, which has an excellent reputation for high precision.

- **Tone control function**

This unit has a tone control function for adjustment of bass (low frequency) and treble (high frequency) sound to produce your preferred tone (🔗 page 25).

- **LOUDNESS function**

This unit is provided with a LOUDNESS function that makes it easier to hear music played back at a low volume level (🔗 page 26).

Easy operation

- **Remote control compatible with CD players and network audio players**

The remote control provided with this unit can control Marantz CD players and network audio players in addition to this unit (🔗 page 12).

This unit can also switch between three remote control codes. When using three units in the same area, you can set a different remote control code for each unit to control them independently (🔗 page 32).



Part names and functions

Front panel

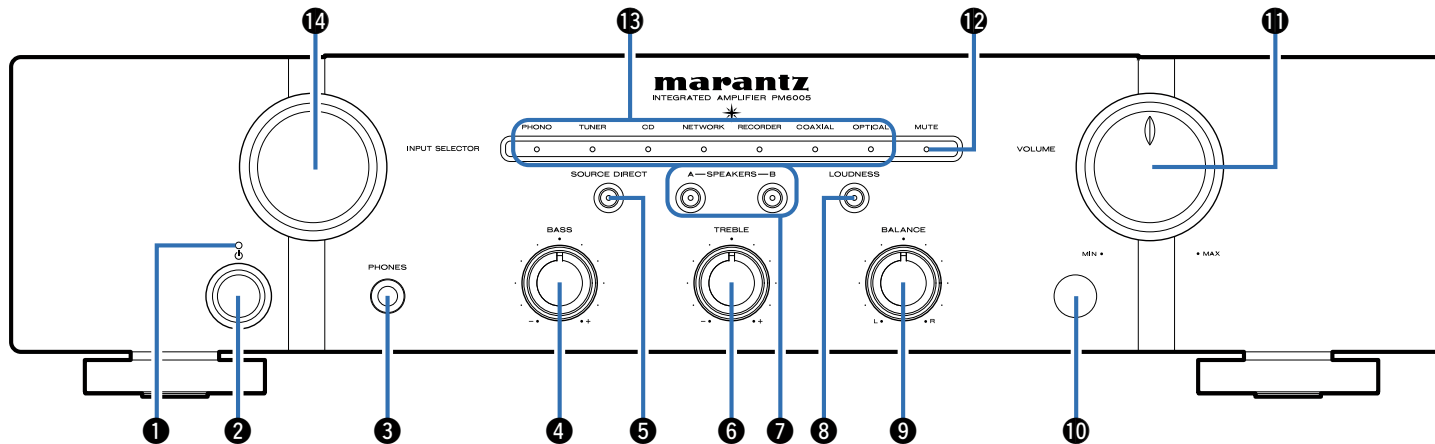

1 Power indicator

This is lit as follows according to the power status :

- Power on : Off
- Standby : Red
- Power off : Off
- When the protection circuit is activated : Red (blinking)

2 Power operation button (⏻)

This turns the power on/off (refer page 24).

3 Headphone jack (PHONES)

Used to connect headphones.

Turn off speaker output when using headphones (refer page 25).

NOTE

- To prevent hearing loss, do not raise the volume level excessively when using headphones.



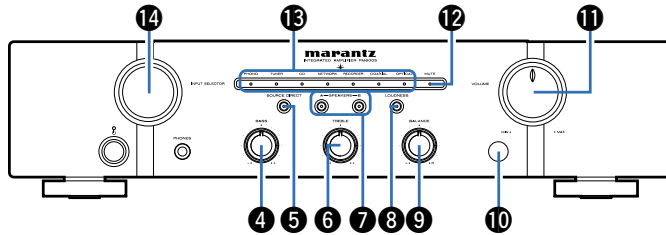

4 BASS control knob

This adjusts the bass (page 25).

5 SOURCE DIRECT button/indicator

This turns SOURCE DIRECT mode on/off (page 25, 29).

6 TREBLE control knob

This adjusts the treble (page 25).

7 Speaker switching buttons/indicators (SPEAKERS A/B)

These select the speaker for audio output (page 25).

8 LOUDNESS button/indicator

This turns LOUDNESS mode on/off (page 26).

9 BALANCE control knob

This adjusts the balance of the volume output from the left and right speakers (page 25).

10 Remote control sensor

This receives signals from the remote control unit (page 5).

11 VOLUME control knob

This adjusts the volume level (page 24, 25).

12 MUTE indicator

This lights while the sound is muted (page 25, 30).

13 Input indicator (page 25)

14 Input source select knob (INPUT SELECTOR)

This selects the input source (page 25).

NOTE

- 4, 6 and 9 can be adjusted when 5 is off (SOURCE DIRECT mode is off).



Rear panel

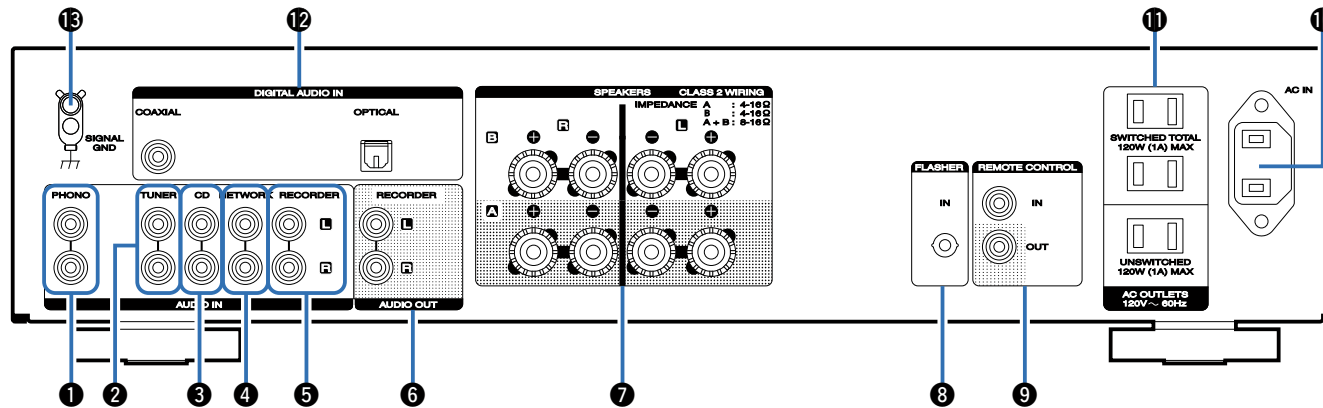

- 1 Turntable input connectors (PHONO)**
Used to connect a turntable (🔗 [page 18](#)).
- 2 Tuner input connectors**
Used to connect a tuner (🔗 [page 18](#)).
- 3 CD input connectors**
Used to connect a CD player (🔗 [page 18](#)).
- 4 Network audio player input connectors (NETWORK)**
Used to connect a network audio player (🔗 [page 18](#)).
- 5 Recorder input connectors (RECORDER)**
Used to connect the output connector of a recorder (🔗 [page 19](#)).
- 6 RECORDER output connectors (RECORDER)**
Used to connect the input connector of a recorder (🔗 [page 19](#)).
- 7 Speaker system terminals (SPEAKERS)**
Used to connect speakers (🔗 [page 15](#)).
- 8 FLASHER IN jack**
Used when using a control BOX or other such control devices to control this unit.
- 9 Remote control input/output connectors (REMOTE CONTROL)**
Used to connect to a Marantz audio device that is compatible with the remote control function (🔗 [page 21](#)).
- 10 AC inlet (AC IN)**
Used to connect the power cord (🔗 [page 22](#)).
- 11 AC outlets (AC OUTLETS)**
Used to connect the AC outlets of this unit in order to supply power to other AV equipment (🔗 [page 22](#)).
- 12 Digital audio input connectors (COAXIAL/OPTICAL)**
Used to connect a device with a TV or digital audio connector (🔗 [page 20](#)).
- 13 SIGNAL GND jacks**
Used to connect a turntable (🔗 [page 18](#)).



Remote control unit

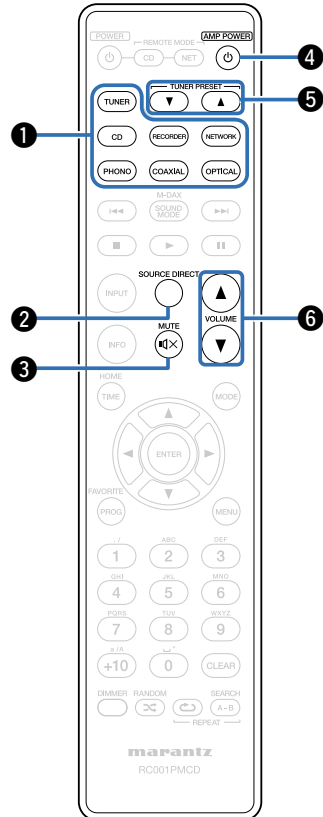

Amplifier and Tuner operation

- 1 Input source select buttons**
 These select the input source (☞ page 25).
- 2 SOURCE DIRECT button**
 This turns SOURCE DIRECT mode on/off (☞ page 26, 29).
- 3 MUTE button (M)**
 This mutes the audio (☞ page 25).
- 4 AMP POWER button (⏻)**
 This turns the power on/off (standby) (☞ page 24).
- 5 TUNER PRESET buttons (▲▼)**
 These select the radio stations registered as preset stations in the tuner.
- 6 VOLUME buttons (▲▼)**
 These adjust the volume level (☞ page 25).



- 5 is operation buttons for Marantz tuners.



CD player operation

To operate Marantz CD player, press REMOTE MODE CD button to switch the remote control to the CD operation mode.

- REMOTE MODE CD button lights for approximately two seconds.

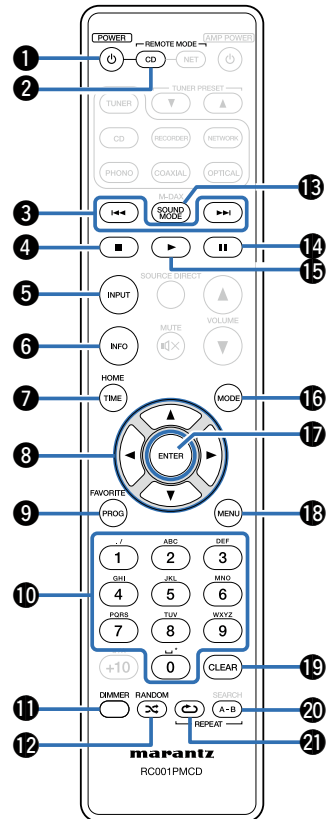

- 1 POWER button (⏻)
- 2 Remote mode select button (REMOTE MODE CD)
- 3 Reverse-skip/Forward-skip buttons (⏮, ⏭)
- 4 Stop button (■)
- 5 Input source select button (INPUT)
- 6 Information button (INFO)
- 7 TIME button
- 8 Cursor buttons (⬆, ⬇, ⬅, ➡, ⬆, ⬇, ⬅, ➡)
- 9 Program button (PROG)
- 10 Number buttons (0 – 9)
- 11 DIMMER button
- 12 RANDOM button (⚡)
- 13 SOUND MODE button
- 14 Pause button (⏸)
- 15 Play button (▶)
- 16 Playback mode switching button (MODE)
- 17 ENTER button
- 18 MENU button
- 19 CLEAR button
- 20 REPEAT A-B button (A-B)
- 21 REPEAT button (↺)



- The amp and tuner can be operated with the amp operation buttons even when the remote control operation mode is set to CD.



Network audio player operation

To operate Marantz network audio player, press REMOTE MODE NET button to switch the remote control to the NETWORK operation mode.

- REMOTE MODE NET button lights for approximately two seconds.

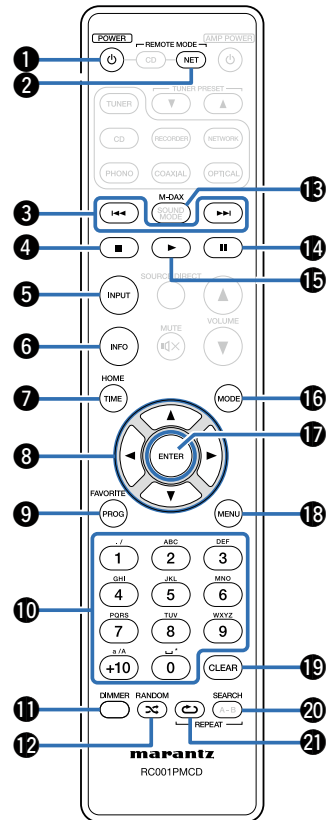

- ❶ POWER button (⏻)
- ❷ Remote mode select button (REMOTE MODE NET)
- ❸ Reverse-skip/Forward-skip buttons (⏮, ⏭)
- ❹ Stop button (■)
- ❺ Input source select button (INPUT)
- ❻ Information button (INFO)
- ❼ HOME button
- ❽ Cursor buttons (⬆, ⬇, ⬅, ⬇)
- ❾ FAVORITE button
- ❿ Number buttons (0 – 9, +10)

- ⓫ DIMMER button
- ⓬ RANDOM button (⚡)
- ⓭ M-DAX button
- ⓮ Pause button (⏸)
- ⓯ Play button (▶)
- ⓰ Playback mode switching button (MODE)
- ⓱ ENTER button
- ⓲ MENU button
- ⓳ CLEAR button
- ⓴ SEARCH button
- ⓵ REPEAT button (↺)



- The amp and tuner can be operated with the amp operation buttons even when the remote control mode is NET.



Connections

Speaker connection (👉 page 15)

Connecting a playback device (👉 page 18)

Connecting a recording device (👉 page 19)

Connecting a TV/Devices with digital audio connectors
(👉 page 20)

Connecting devices with remote control connectors
(👉 page 21)





Connecting the power cord (👉 page 22)

NOTE

- Do not plug in the power cord until all connections have been completed.
- Do not bundle power cords with connection cables. Doing so can result in humming or noise.

■ Cables used for connections

Provide necessary cables according to the devices you want to connect.

Speaker cable	
Coaxial digital cable	
Optical cable	
Audio cable	
Remote connector cable	



Speaker connection

NOTE

- Disconnect this unit's power plug from the power outlet before connecting the speakers.
- Connect so that the speaker cable core wires do not protrude from the speaker terminal. The protection circuit may be activated if the core wires touch the rear panel or if the + and - sides touch each other (see page 40 "Protection circuit").
- Never touch the speaker terminals while the power cord is connected.
- Use speakers with impedances within the ranges shown below to suit how they are used.

Speakers used	Impedance
SPEAKERS A (Standard connection)	4 – 16 Ω /ohms
SPEAKERS B	4 – 16 Ω /ohms
SPEAKERS A and SPEAKERS B	8 – 16 Ω /ohms
SPEAKERS A and SPEAKERS B (for bi-wiring connections)	4 – 16 Ω /ohms

Connecting the speakers cables

Carefully check the left (L) and right (R) channels and + (red) and - (black) polarities on the speakers being connected to the unit, and be sure to connect the channels and polarities correctly.

- 1 Peel off about 3/8 inch (10 mm) of sheathing from the tip of the speaker cable, then either twist the core wire tightly or apply solder to it.**



- 2 Turn the speaker terminal counterclockwise to loosen it.**



- 3 Insert the speaker cable's core wire to all the way into the speaker terminal.**



- 4 Turn the speaker terminal clockwise to tighten it.**

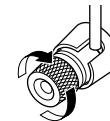

Speaker A/B connection

- The same signal is output from the SPEAKERS A and SPEAKERS B terminals.
- When only one set of speakers is to be connected, use either the SPEAKERS A or SPEAKERS B terminals.

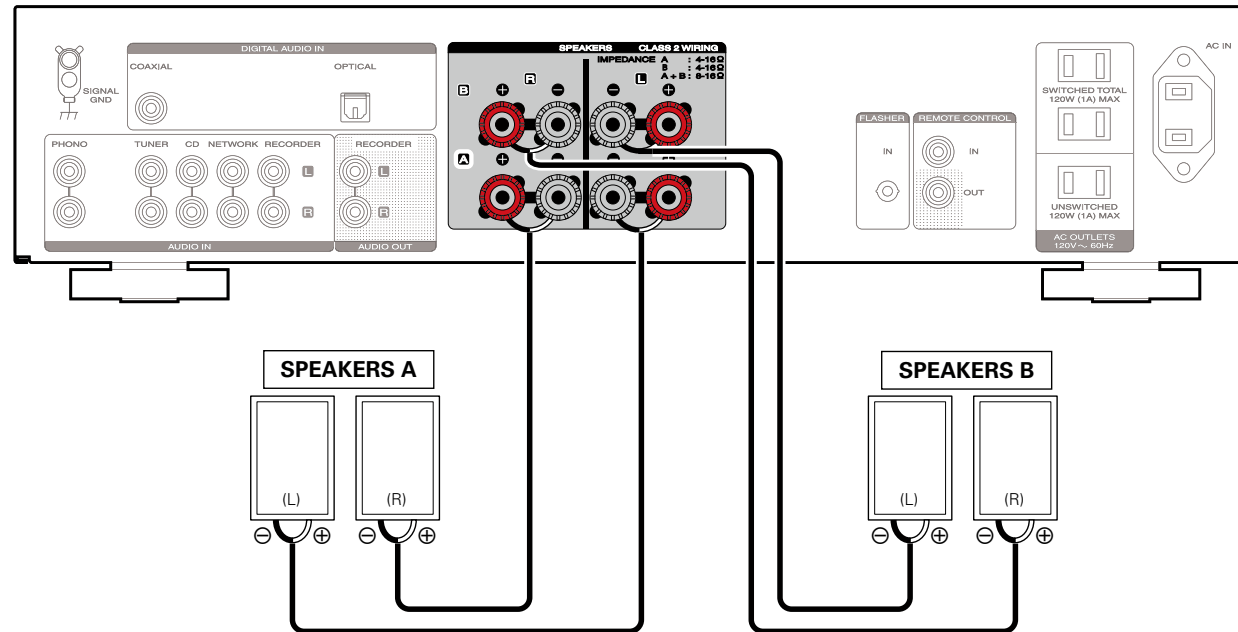

Bi-wiring connection

- When bi-wiring with bi-wireable speakers, connect the mid and high range terminals to SPEAKERS A (or SPEAKERS B), the low range terminals to SPEAKERS B (or SPEAKERS A).
- This connection limits the effect of signal interference between the high range speakers and low range speakers, allowing you to enjoy high quality playback.

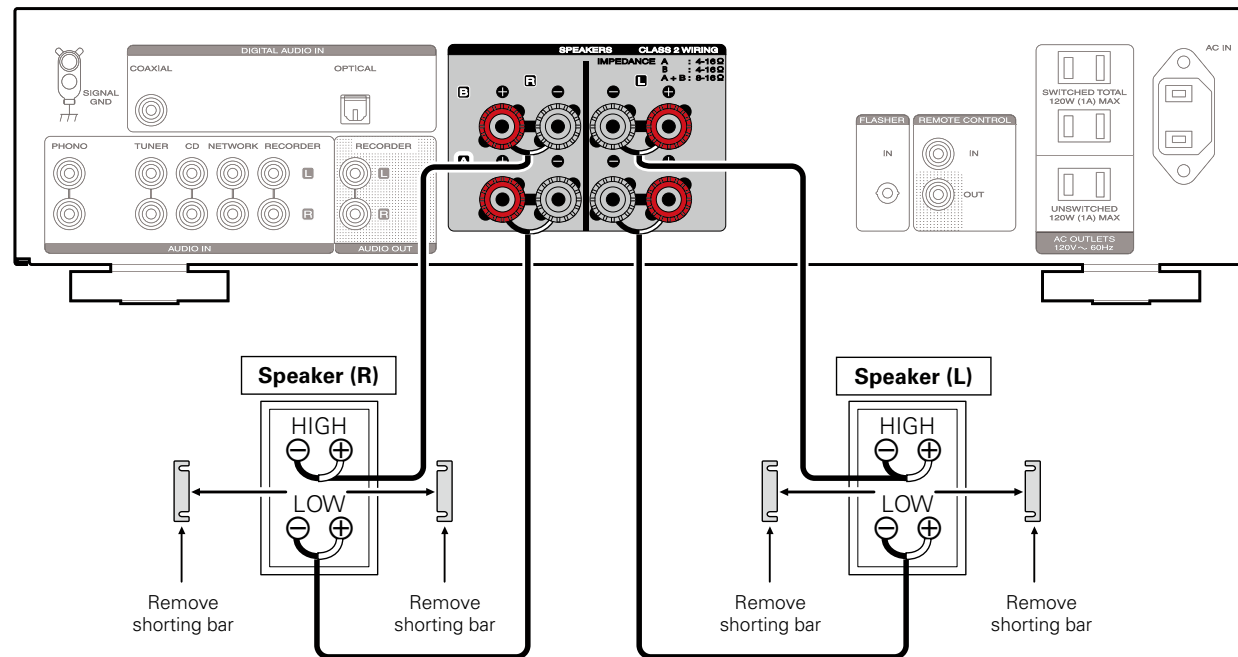

Connecting a playback device

You can connect turntables, tuners, CD players and network audio players to this unit.

This unit is compatible with turntables equipped with a moving magnet (MM) phono cartridge. When you connect to a turntable with a low output moving coil (MC) cartridge, use a commercially available MC head amp or a step-up transformer.

If you set this unit's input source to "PHONO" and you accidentally increase the volume without having a turntable connected, you may hear a hum noise from the speakers.

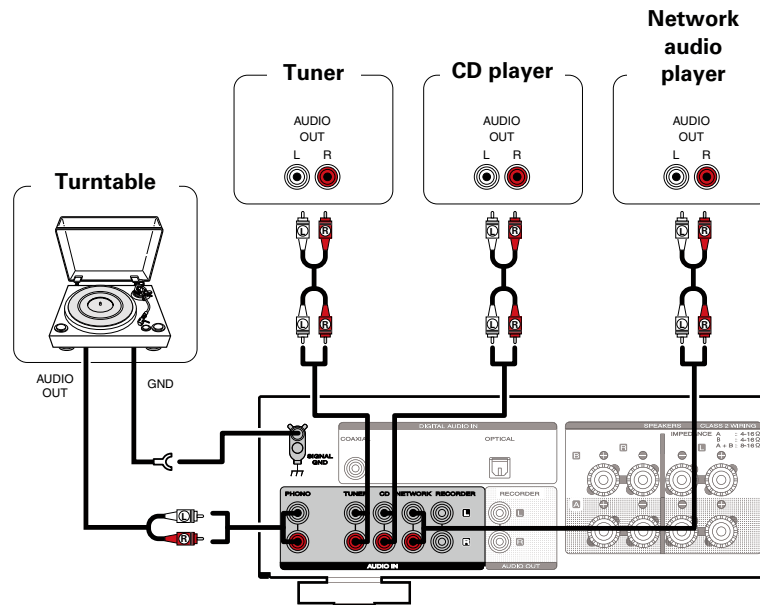

NOTE

- The ground line (SIGNAL GND) on this unit is not a safety ground. Connect it to reduce noise when noise is excessive. Note that depending on the turntable, connecting the ground line may have the reverse effect of increasing noise. In this case, it is not necessary to connect the ground line.



Connecting a recording device

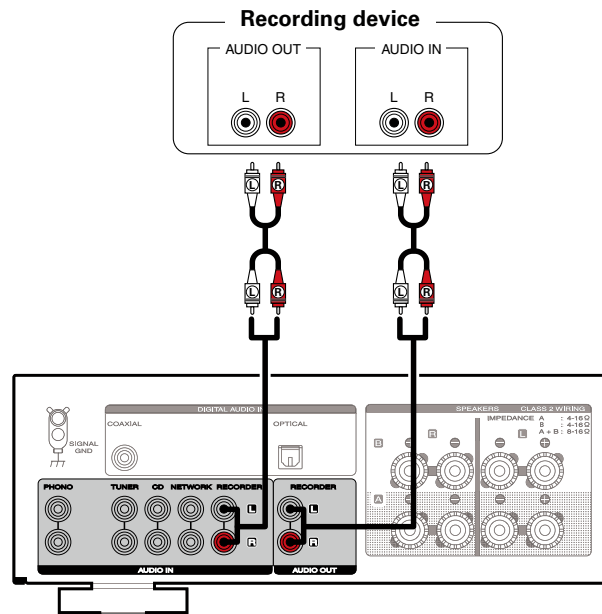

NOTE

- Never insert the short-circuiting pin plug into the recording output connectors (REORDER). Doing so could result in damage.



Connecting a TV/Devices with digital audio connectors

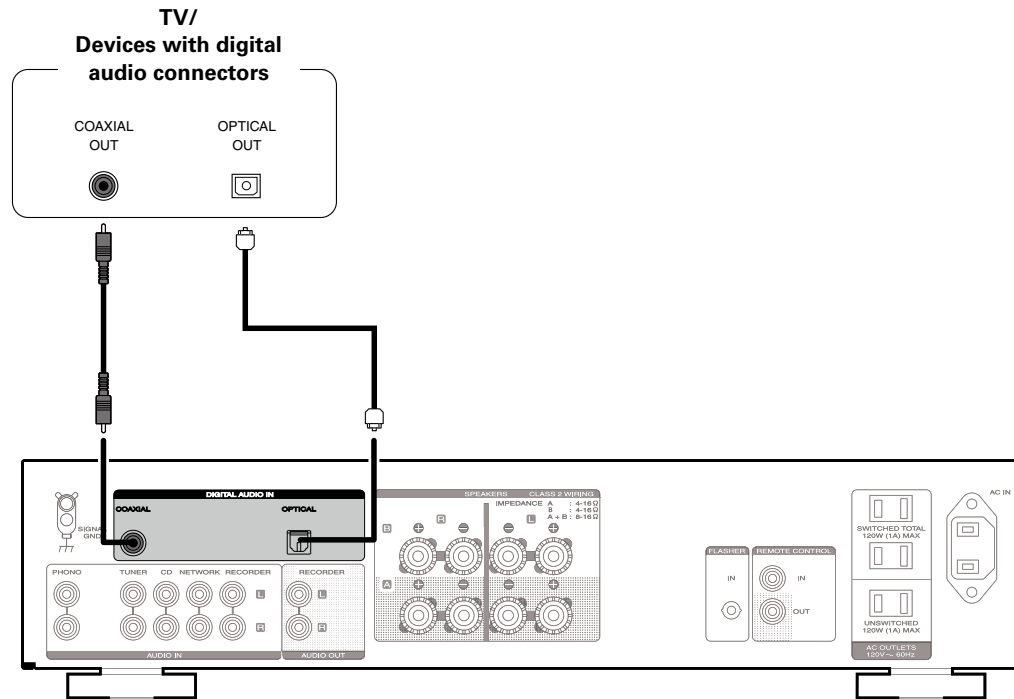

Connecting devices with remote control connectors

Performing operations by RC on this unit without visual contact

You can connect an external IR receiver to the REMOTE CONTROL connectors to perform operations on this unit without visual contact. This might be necessary if the unit is hidden in a cupboard or corner, so you can't directly point with the remote control unit to the device.

To do this, disable the remote control signal receiving function (see page 30 "Setting the remote signal receiving function of the remote control unit").

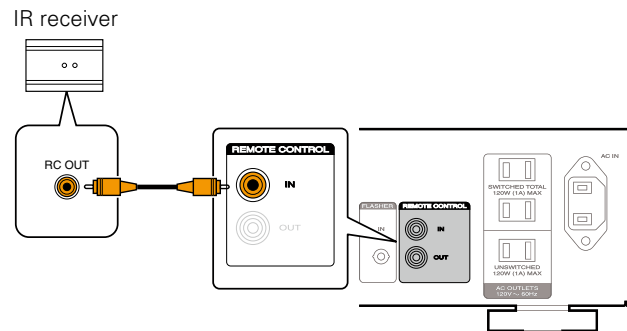

NOTE

- When the remote control signal receiving function is disabled, you can not perform operations with the remote control unit.

Remotely connecting Marantz devices

You can transmit remote control signals simply by connecting a Marantz audio device to the REMOTE CONTROL IN/OUT connectors using the remote connection cable provided with the device.

Set the remote control switch located on the rear panel of the connected audio component to "EXTERNAL" to use this feature.

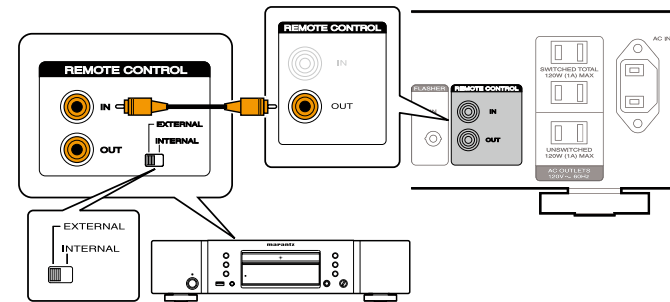

Connecting the power cord

Wait until all connections have been completed before connecting the power cord.

■ Connection to the AC outlet

You can use the AC outlets of this unit to supply power to other AV equipment.

❑ SWITCHED

The "SWITCHED" AC outlet turns on/off the power supply in sync with power on/standby of this unit.

You can connect AV equipment that has total power consumption of up to 120 W (1A).

❑ UNSWITCHED

The "UNSWITCHED" AC outlet supplies power regardless of power on/standby of this unit.

You can connect AV equipment that has maximum power consumption of up to 120 W (1A).

WARNING :

Do not connect AV equipment exceeding the absolute allowable power. If you do, it could result in fire or electric shock.

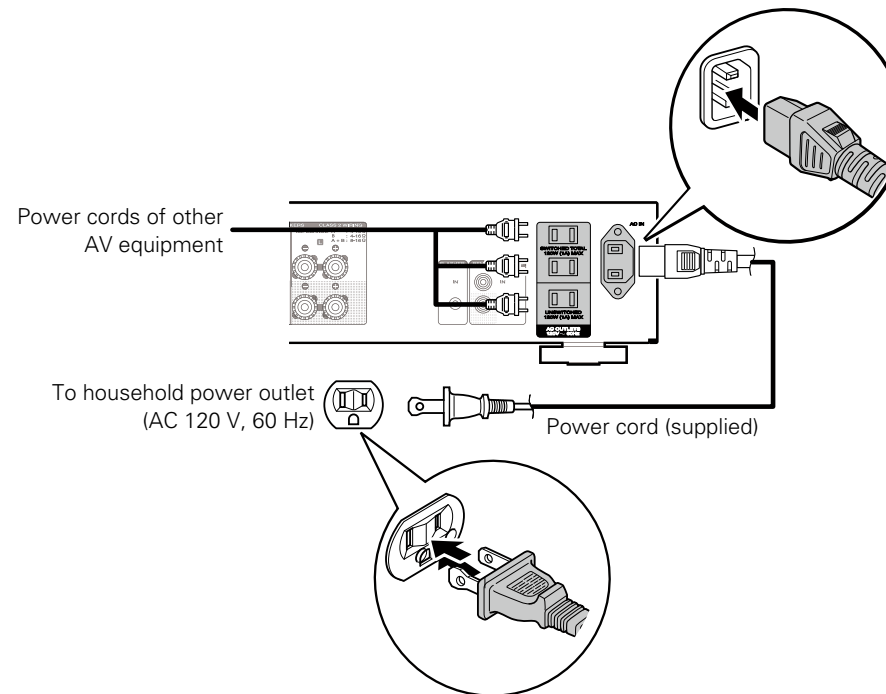

Playback

Turning the power on (👉 page 24)

Selecting the speakers for audio output (👉 page 25)

Selecting the input source (👉 page 25)

Adjusting the volume (👉 page 25)

Turning off the sound temporarily (👉 page 25)

Adjusting the tone (👉 page 25)

Playing CDs (👉 page 26)

Recording (👉 page 27)



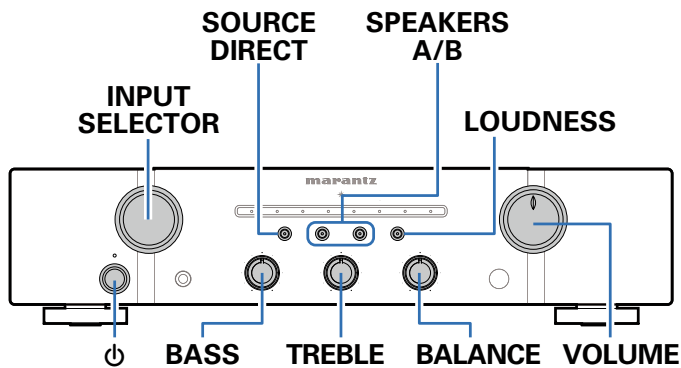
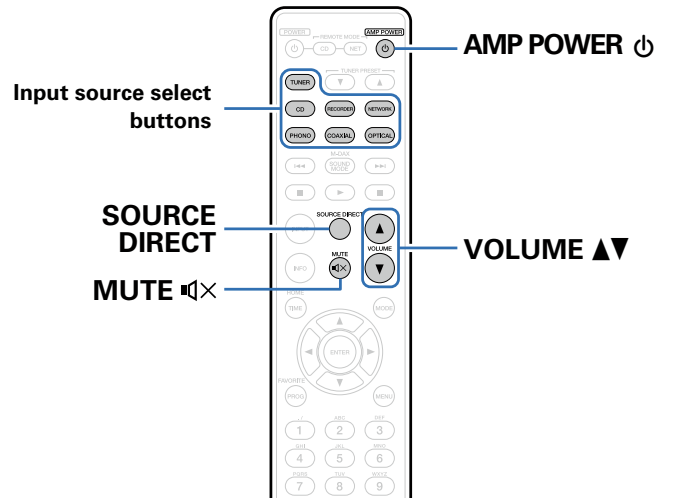

Front panel

Rear panel

Remote

Turning the power on

- 1 Press ⏻ on this unit to turn the power on.
Input indicator for the selected source lights.



- Press AMP POWER ⏻ to turn on power from standby mode.
- You can also turn on power by using either INPUT SELECTOR on this unit from standby mode.

NOTE

- Turn VOLUME on this unit to adjust the volume to the lowest level before turning on the power.

Turning the power off

- 1 Press AMP POWER ⏻ .
The standby indicator lights in red.
- 2 Press ⏻ on this unit to turn the power off.
All indicators turn off.



Selecting the speakers for audio output

- 1 Press **SPEAKERS A/B** to select the speaker system to be used for playback.

The indicator of the selected speakers lights.

Selecting the input source

- 1 Press the **input source select button** to be played back.

The indicator of the selected input source lights.



- You can also select the input source by turning **INPUT SELECTOR** on the main unit.

Adjusting the volume

- 1 Use **VOLUME ▲▼** to adjust the volume.



- You can also adjust the volume by turning **VOLUME** on the main unit.

Turning off the sound temporarily

- 1 Press **MUTE**

The mute indicator lights.



- Muting can be cancelled by pressing **MUTE**

Adjusting the tone

- 1 Press **SOURCE DIRECT** on this unit to turn off source direct mode.
- 2 Turn the **BASS**, **TREBLE** and **BALANCE** control knobs to adjust the tone.



Playing CDs

This section uses playback from a CD as an example.

- 1 Press **⏻** on this unit to turn the power on.
- 2 Press the input source select buttons to switch the input source to "CD".
The "CD" input indicator lights.
- 3 Playback the CD.
- 4 Use **VOLUME ▲▼** to adjust the volume.

■ Playback in source direct mode

The signal does not pass through the tone adjustment circuitry (BASS, TREBLE and BALANCE), resulting in playback of a higher sound quality.

- 1 Press **SOURCE DIRECT** to turn on source direct mode.
The SOURCE DIRECT indicator lights.

■ Playback in LOUDNESS mode

When music is played at a low volume level, the effect of the bass and treble cannot be heard easily. The LOUDNESS function corrects the low range and high range tones in these situations, allowing you to enjoy natural-sounding playback.

- 1 Press **LOUDNESS** to turn on LOUDNESS mode.
The LOUDNESS indicator lights.



Recording

- 1 Press  on this unit to turn the power on.**
- 2 Press the input source select buttons to switch to the input source from which you want to record.**
The indicator of the selected input source lights.
- 3 Recording starts.**
 - For information on operations, see the owner's manual of the recording device.



Settings

Setting the Auto Standby mode (👉 page 29)

Setting the remote signal receiving function of the remote control unit (👉 page 30)

Setting remote control codes (👉 page 31)



Setting the Auto Standby mode

You can set the unit to automatically switch to standby mode if the unit is not operated for 30 minutes when there is no audio input. Auto Standby mode is set to on by default.

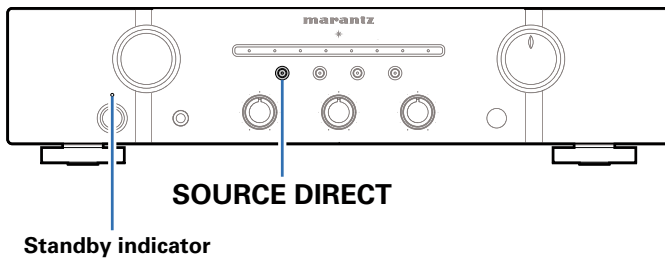

Turning Auto Standby mode off

- 1 Press and hold **SOURCE DIRECT** for more than 5 seconds to turn the Auto Standby mode off.
The power indicator flashes once.

Turning Auto Standby mode on

- 1 Press and hold **SOURCE DIRECT** for more than 5 seconds to turn the auto standby mode on.
The standby indicator flashes three times.



Setting the remote signal receiving function of the remote control unit

When you connect a IR receiver (sold separately) to the REMOTE CONTROL IN connector of this unit, use the following procedure to disable the remote signal receiving function of this unit. When the function is enabled, you can not perform operations with the remote control unit. By default, this function is enabled.

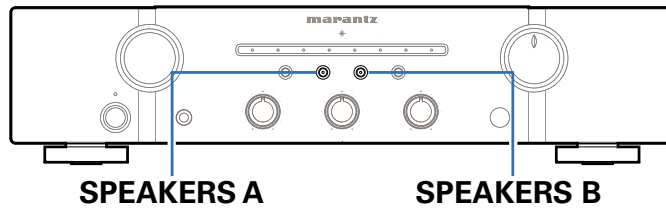

Disabling the remote signal receiving function of the remote control unit

- 1 While the remote signal receiving function of this unit is enabled, press and hold **SPEAKERS B** for about **5 seconds**.

The mute indicator flashes once, and the remote signal receiving function is disabled.

Enabling the remote signal receiving function of the remote control unit

- 1 While the remote signal receiving function of this unit is disabled, press and hold **SPEAKERS A** for about **5 seconds**.

The mute indicator flashes three times, and the remote signal receiving function is enabled.



Setting remote control codes

When three of these units are used in the same location, each unit can be controlled independently by setting separate remote control codes.

Be sure to check the operation of each unit after setting the remote control codes.

The default setting is "AMP1".

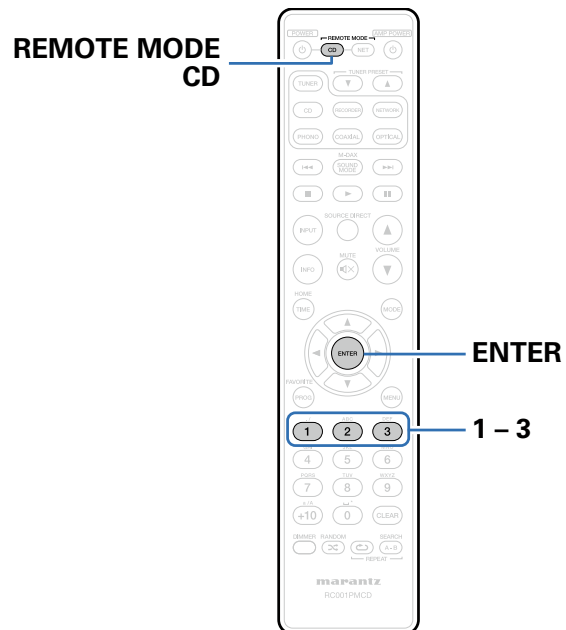

Setting remote control codes for the remote control

■ To set the remote control codes to AMP2

- 1 Press and hold REMOTE MODE CD and number button 2 for 5 seconds or longer.

■ To set the remote control codes to AMP3

- 1 Press and hold REMOTE MODE CD and number button 3 for 5 seconds or longer.

NOTE

- To restore the remote control code default setting, press and hold REMOTE MODE CD and number button 1 for 5 seconds or longer.
- The remote control codes returns to the default settings when the batteries are removed. Set the remote control codes again after replacing the batteries.



Setting remote control codes for this unit

1 Hold down **REMOTE MODE CD** and press **ENTER**.

When remote control codes are set, the following input indicators on this unit are displayed according to the set remote control code.

Remote control codes	Input indicator
AMP 1	CD indicator flashes three times
AMP 2	NETWORK indicator flashes three times
AMP 3	RECORDER indicator flashes three times



Tips

Contents

■ Tips	(34)	■ Troubleshooting	(35)
I want to play back high quality television sound	(34)	Power does not turn on / Power is turned off	(35)
I want to adjust the tone myself	(34)	Operations cannot be performed through the remote control	
I want sound playback that is faithful to the original sound	(34)	unit	(37)
I want to hear music that is close to the original sound quality		No sound comes out	(38)
at low volume.....	(34)	Desired sound does not come out.....	(39)
I want to operate a Marantz CD player or network audio player		Sound is interrupted or noise occurs.....	(39)
using the remote control from of unit	(34)		
I want to use more than one unit in one location.....	(34)		



Tips

I want to play back high quality television sound

- Connect the digital audio output connector of the TV to the digital audio input connector (COAXIAL or OPTICAL) of this unit, and switch the input source to the connected (COAXIAL or OPTICAL) connector ([ⓘ page 20, 25](#)).
- This unit can play back 2 channel linear PCM digital audio signals.

I want to adjust the tone myself

- Use the BASS, TREBLE and BALANCE knobs to adjust the sound as desired ([ⓘ page 25](#)).

I want sound playback that is faithful to the original sound

- Set the Source Direct mode on ([ⓘ page 25](#)).

I want to hear music that is close to the original sound quality at low volume

- Turn the LOUDNESS mode on ([ⓘ page 26](#)).

I want to operate a Marantz CD player or network audio player using the remote control of this unit

- Switch the remote control operating mode ([ⓘ page 12, 13](#)).
- Also refer to the CD player or network audio player instruction manuals.

I want to use more than one unit in one location

- Set individual remote control codes for each combination of devices and remote control ([ⓘ page 31, 32](#)).



Troubleshooting

If a problem occurs, first check the following:

1. Are the connections correct?
2. Is the unit being operated as described in the owner's manual?
3. Are the other components operating properly?

If this unit does not operate properly, check the items listed in the table below. If the problem persists there may be a malfunction.

In that case, disconnect the power immediately and contact your retail outlet.

■ Power does not turn on / Power is turned off

Symptom	Cause / Solution	Page
Power does not turn on.	<ul style="list-style-type: none"> • Check whether the power plug is correctly inserted into the power outlet. 	<u>22</u>
Power automatically turns off.	<ul style="list-style-type: none"> • The Auto Standby mode is set. The Auto Standby mode switches the unit to standby mode when the unit is not operated for approximately 30 minutes. To disable the Auto Standby mode, press and hold the SOURCE DIRECT button on the unit for more than 5 seconds when the Auto Standby mode is enabled. 	<u>29</u>



Symptom	Cause / Solution	Page
Power turns off and the power indicator flashes in red approx. every 0.25 seconds.	• Due to the temperature rise within this unit, the protection circuit is working. Turn off the power and wait about an hour until this unit sufficiently cools down. Then, turn on the power again.	<u>40</u>
	• Please re-install this unit in a place having good ventilation.	-
	• Check the speaker connection. The protection circuit may have been activated because speaker cable core wires came in contact with each other or a core wire was disconnected from the connector and came in contact with the rear panel of this unit. After unplugging the power cord, take corrective action such as firmly re-twisting the core wire or taking care of the connector, and then reconnect the wire.	<u>15</u>
	• Turn down the volume and turn on the power again.	<u>24, 25</u>
	• This unit's amplifier circuit has failed. Turn off the power and please contact the Marantz service adviser.	-



■ Operations cannot be performed through the remote control unit

Symptom	Cause / Solution	Page
Operations cannot be performed through the remote control unit.	• Batteries are worn out. Replace with new batteries.	<u>5</u>
	• Operate the remote control unit within a distance of about 23 ft/7 m from this unit and at an angle of within 30°.	<u>5</u>
	• Remove any obstacle between this unit and the remote control unit.	–
	• Insert the batteries in the proper direction, checking the ⊕ and ⊖ marks.	<u>5</u>
	• The set's remote control sensor is exposed to strong light (direct sunlight, inverter type fluorescent bulb light, etc.). Move the set to a place in which the remote control sensor will not be exposed to strong light.	–
	• When using a 3D video device, the remote control unit of this unit may not function due to effects of infrared communications between units (such as TV and glasses for 3D viewing). In this case, adjust the direction of units with the 3D communications function and their distance to ensure they do not affect operations from the remote control unit of this unit.	–
	• Enable the remote signal receiving function.	<u>30</u>
• Set the combination of this unit and the remote control to the same remote control code.	<u>31, 32</u>	



■ No sound comes out

Symptom	Cause / Solution	Page
No sound comes out of speakers.	• Check the connections for all devices.	14
	• Insert connection cables all the way in.	–
	• Check that input connectors and output connectors are not reversely connected.	–
	• Check cables for damage.	–
	• Check that speaker cables are properly connected. Check that cable core wires come in contact with the metal part on speaker terminals. Also, securely tighten speaker terminals. Check speaker terminals for looseness.	15
	• Check that a proper input source is selected.	25
	• Adjust the volume.	26
	• Cancel the mute mode.	26
The COAXIAL or OPTICAL input indicator is flashing.	• Check the connection of the Coaxial digital cable or Optical cable.	20
	• Set the Digital Audio output signal of the connected device to 2 channel linear PCM.	40



■ Desired sound does not come out

Symptom	Cause / Solution	Page
No sound comes out of a specific speaker.	<ul style="list-style-type: none"> • Check that the speaker cable is properly connected. • Adjust the BALANCE control knob. 	15 26
The left and right of stereo sound is reversed.	<ul style="list-style-type: none"> • Check whether the left and right speakers are connected to the correct speaker terminals. 	15

■ Sound is interrupted or noise occurs

Symptom	Cause / Solution	Page
When playing a record, the sound is distorted.	<ul style="list-style-type: none"> • Adjust to a proper needle pressure. • Check the tip of the needle. • Replace the cartridge. 	- - -
When playing a record, a humming noise comes out of the speakers.	<ul style="list-style-type: none"> • Check that the turntable is connected correctly. • If there is a TV or AV device near the turntable, such devices may affect the playback sound. Install the turntable in a location as far away as possible from the TV or other AV devices. 	18 -
When playing a record at high volume, a "howling" sound comes out of the speakers.	<ul style="list-style-type: none"> • Install the turntable and speakers as far from each other as possible. • The vibrations from the speakers are being transmitted to the player through the floor. Use cushions, etc., to absorb the speakers' vibrations. 	18 -



Appendix

Playback on devices that have digital audio terminals

■ Supported audio formats

	Sampling frequency	Bit length
2-channel Linear PCM	32/44.1/48/64/88.2/96/176.4/192 kHz	16/24 bit



- When a digital sound signal that has a sampling frequency that is not supported by this unit is input, the input indicator (COAXIAL or OPTICAL) flashes in the display.

NOTE

- Do not input non-PCM signals, such as Dolby Digital, and DTS. This causes noise and could damage the speakers.
- If the sampling frequency switches, such as from A mode to B mode in a CS broadcast, muting may operate for 1 – 2 seconds, cutting the sound.

Explanation terms

P

Protection circuit

This is a function to prevent damage to devices within the power supply when an abnormality such as an overload, excess voltage occurs or over temperature for any reason.

If a malfunction occurs in this unit, the power indicator blinks red and the unit switches to standby mode.

S

Sampling frequency

Sampling involves taking a reading of a sound wave (analog signal) at regular intervals and expressing the height of the wave at each reading in digitized format (producing a digital signal).

The number of readings taken in one second is called the “sampling frequency”. The larger the value, the closer the reproduced sound is to the original.

Source direct

Playback with higher fidelity to the source becomes possible, as input audio signals are output by bypassing the audio quality-control circuits (BASS/TREBLE/BALANCE).

Speaker impedance

This is an AC resistance value, indicated in Ω (ohms). Greater power can be obtained when this value is smaller.



Specifications

<ul style="list-style-type: none"> • RMS Power output (20 Hz – 20 kHz simultaneous drive of both channels) : 	45 W x 2 (8 Ω/ohms load) 60 W x 2 (4 Ω/ohms load)
<ul style="list-style-type: none"> • Total harmonic distortion (20 Hz – 20 kHz simultaneous drive of both channels, 8 Ω/ohms load) : 	0.08 %
<ul style="list-style-type: none"> • Output band width (8 Ω/ohms load, 0.06 %) : 	10 Hz – 50 kHz
<ul style="list-style-type: none"> • Frequency response (CD, 1 W, 8 Ω/ohms load) : 	10 Hz – 70 kHz +0 dB, -1 dB
<ul style="list-style-type: none"> • Dumping factor (8 Ω/ohms load, 40 Hz – 20 kHz) : 	100
<ul style="list-style-type: none"> • Input sensitivity/Input impedance PHONO (MM) : 	2.2 mV/47 kΩ/kohms
<ul style="list-style-type: none"> CD, TUNER, NETWORK, RECORDER : 	200 mV/20 kΩ/kohms
<ul style="list-style-type: none"> • Maximum allowable PHONO input level (1 kHz) MM : 	100 mV
<ul style="list-style-type: none"> • RIAA deviation (20 Hz – 20 kHz) : 	±1.0 dB
<ul style="list-style-type: none"> • S/N (IHF-A, 8 Ω/ohms load) PHONO (MM) : 	83 dB (5 mV input, 1 W output)
<ul style="list-style-type: none"> CD, TUNER, NETWORK, RECORDER : 	102 dB (2 V input, Rated output)
<ul style="list-style-type: none"> • Tone control Bass (50 Hz) : 	±10 dB
<ul style="list-style-type: none"> Treble (15 kHz) : 	±10 dB
<ul style="list-style-type: none"> • Digital input Coaxial : 	0.5 Vp-p
<ul style="list-style-type: none"> Optical : 	-27 dBm or later
<ul style="list-style-type: none"> • Power requirement : 	AC 120 V, 60 Hz
<ul style="list-style-type: none"> • Power consumption (UL60065) : 	155 W
<ul style="list-style-type: none"> • Power consumption in standby mode : 	0.3 W

For the purpose of improvement, the specifications and design are subject to change without notice.



Index

A

Accessories.....	4
Adjusting the tone.....	25
BALANCE.....	25
BASS.....	25
TREBLE.....	25
Adjusting the volume.....	25
Auto Standby mode.....	29

C

Cables used for connections.....	14
Connection	
Devices with digital audio terminals.....	20
Players.....	18
Power cord.....	22
Recording device.....	19
Remote control connectors.....	21
Speaker.....	15, 16
Speaker (Bi-wiring).....	17
TV.....	20

L

LOUDNESS mode.....	26
--------------------	----

P

Protection circuit.....	40
-------------------------	----

R

Remote control unit.....	11
Inserting the batteries.....	5
Setting remote control codes.....	31

S

Sampling frequency.....	40
Selecting the input source.....	25
Source direct.....	26, 40
Speaker impedance.....	40

T

Tips.....	34
Troubleshooting.....	35
Turning off the sound temporarily.....	25
Turning the power on.....	24



■ **Dimensions**

Unit : in. (mm)

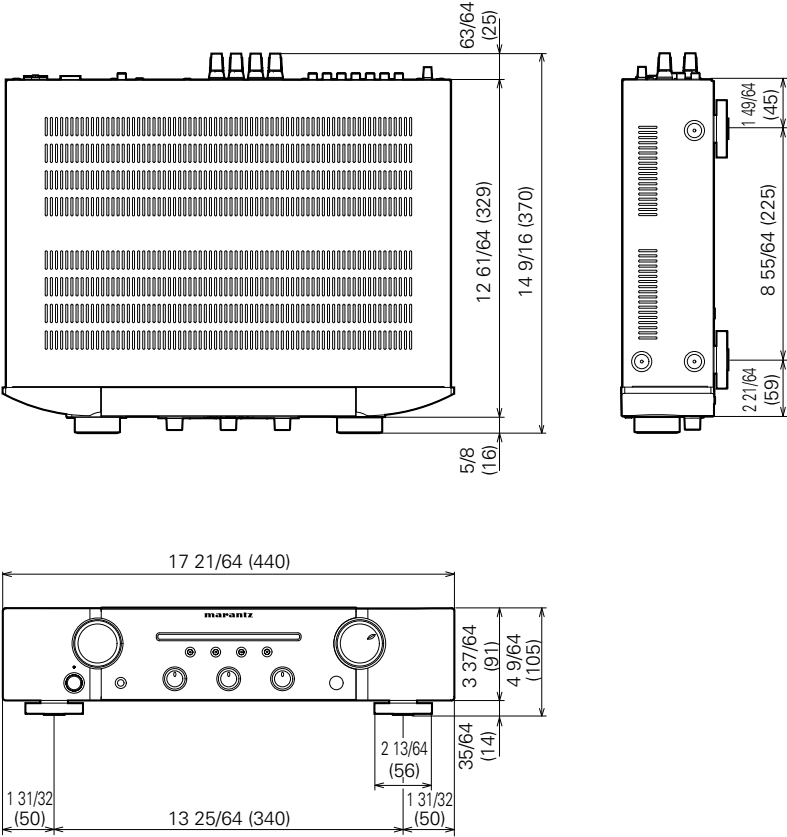

■ **Weight : 16 lbs 12 oz (7.6 kg)**

Front panel

Rear panel

Remote

Index



www.marantz.com

You can find your nearest authorized distributor or dealer on our website.

marantz[®] is a registered trademark.

D&M Holdings Inc.
3520 10289 00AM